



GaAs pHEMT MMIC 2 WATT POWER AMPLIFIER, 15 - 20 GHz

Typical Applications

The HMC6981LS6 is ideal for:

- Point-to-Point Radios
- Point-to-Multi-Point Radios
- SATCOM

Features

- P1dB Output Power: +33.5 dBm
- 25% PAE @ +34.5 dBm Pout
- Gain: 26 dB
- Output IP3: +43.5 dBm
- 50 Ohm Matched Input/Output
- Ceramic 6 x 6 mm High Frequency Air Cavity Package

Functional Diagram

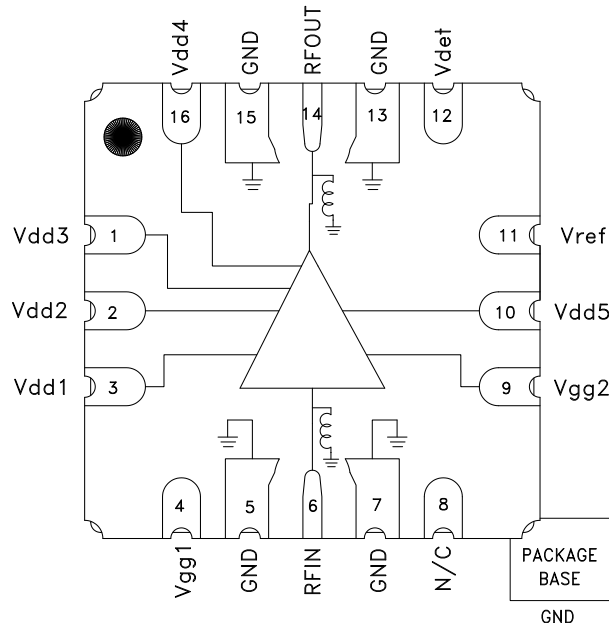

General Description

The HMC6981LS6 is a four-stage GaAs pHEMT MMIC Power Amplifier with an integrated temperature compensated on-chip Power Detector, which operates between 15 and 20 GHz. The amplifier provides 26 dB of gain, +34.5 dBm of saturated output power, and 25% PAE from a +6V supply. With an excellent output IP3 of +43.5 dBm, the HMC6981LS6 is ideal for linear applications such as high capacity point-to-point or point-to-multi-point radios or SATCOM applications demanding +34.5 dBm of efficient saturated output power. The HMC6981LS6 is housed in a ceramic 6 x 6 mm high frequency air cavity package which exhibits low thermal resistance and is compatible with high volume surface mount manufacturing techniques. The RF I/Os are internally matched to 50 Ohms.

Electrical Specifications, $T_A = +25^\circ C$

$V_{dd} = V_{dd1}, V_{dd2}, V_{dd3}, V_{dd4}, V_{dd5} = +6V, I_{dd} = 1100 mA$ [1]

Parameter	Min.	Typ.	Max.	Min.	Typ.	Max.	Units
Frequency Range	15 - 17		17 - 20				GHz
Gain	24	27		23	26		dB
Gain Variation Over Temperature	0.042		0.038				dB/ °C
Input Return Loss	9		13				dB
Output Return Loss	13		15				dB
Output Power for 1 dB Compression (P1dB)	31	33		31.5	33.5		dBm
Saturated Output Power (P _{sat})	34.5		34.5				dBm
Output Third Order Intercept (IP3) ^[2]	42		43.5				dBm
Total Supply Current (I _{dd})	1100		1100				mA

[1] Adjust V_{gg} between -2 to 0V to achieve I_{dd} = 1100 mA typical.

[2] Measurement taken at +6V @ 1100 mA, P_{out} / Tone = +20 dBm

HMC6981* PRODUCT PAGE QUICK LINKS

Last Content Update: 02/23/2017

COMPARABLE PARTS

View a parametric search of comparable parts.

EVALUATION KITS

- HMC6981LS6 Evaluation Board

DOCUMENTATION

Application Notes

- AN-1363: Meeting Biasing Requirements of Externally Biased RF/Microwave Amplifiers with Active Bias Controllers
- Broadband Biasing of Amplifiers General Application Note
- MMIC Amplifier Biasing Procedure Application Note
- Thermal Management for Surface Mount Components General Application Note

Data Sheet

- HMC6981 Data Sheet

TOOLS AND SIMULATIONS

- HMC6981 S-Parameter

REFERENCE MATERIALS

Quality Documentation

- Package/Assembly Qualification Test Report: 20L 7x7mm Ceramic LCC Package (QTR: 11005P REV: 03)
- Semiconductor Qualification Test Report: PHEMT-K (QTR: 2013-00500)

DESIGN RESOURCES

- HMC6981 Material Declaration
- PCN-PDN Information
- Quality And Reliability
- Symbols and Footprints

DISCUSSIONS

View all HMC6981 EngineerZone Discussions.

SAMPLE AND BUY

Visit the product page to see pricing options.

TECHNICAL SUPPORT

Submit a technical question or find your regional support number.

DOCUMENT FEEDBACK

Submit feedback for this data sheet.



GaAs pHEMT MMIC 2 WATT POWER AMPLIFIER, 15 - 20 GHz

Gain & Return Loss

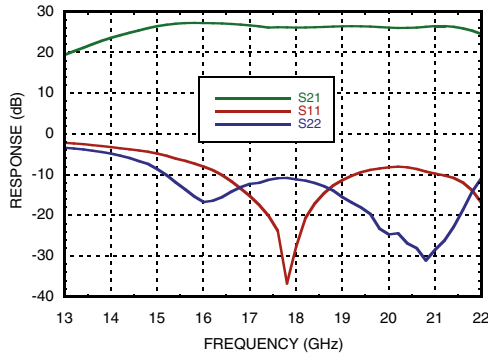

Gain vs. Temperature

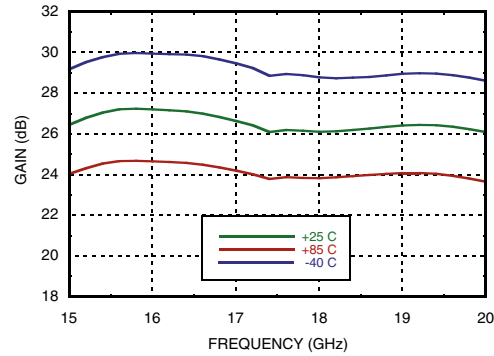

Gain vs. Supply Current

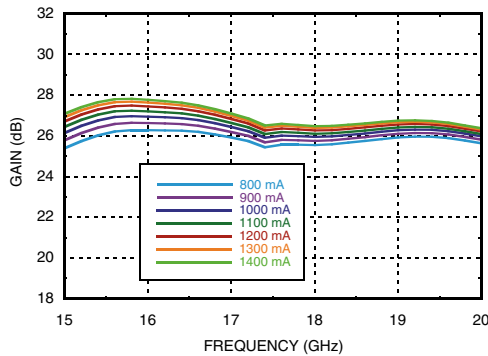

Gain vs. Supply Voltage

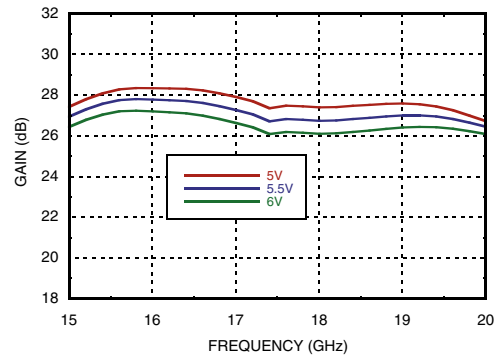

Input Return Loss vs. Temperature

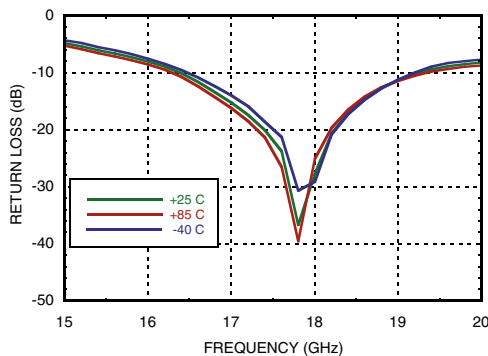

Output Return Loss vs. Temperature

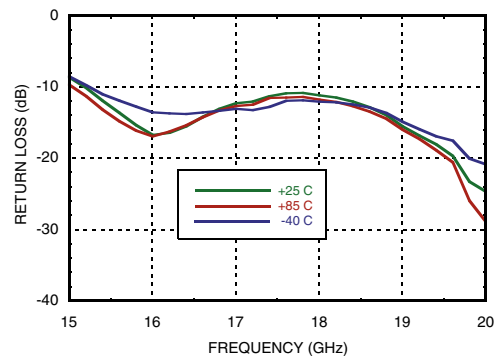

Information furnished by Analog Devices is believed to be accurate and reliable. However, no responsibility is assumed by Analog Devices for its use, nor for any infringements of patents or other rights of third parties that may result from its use. Specifications subject to change without notice. No license is granted by implication or otherwise under any patent or patent rights of Analog Devices. Trademarks and registered trademarks are the property of their respective owners.

For price, delivery, and to place orders: Analog Devices, Inc., One Technology Way, P.O. Box 9106, Norwood, MA 02062-9106 Phone: 781-329-4700 • Order online at www.analog.com Application Support: Phone: 1-800-ANALOG-D



**GaAs pHEMT MMIC 2 WATT
POWER AMPLIFIER, 15 - 20 GHz**

AMPLIFIERS - LINEAR & POWER - SMT

P1dB vs. Temperature

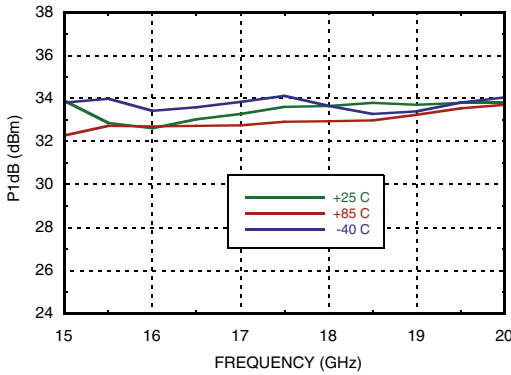

P1dB vs. Supply Voltage

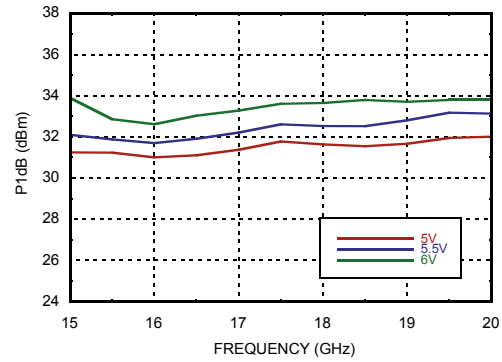

Psat vs. Temperature

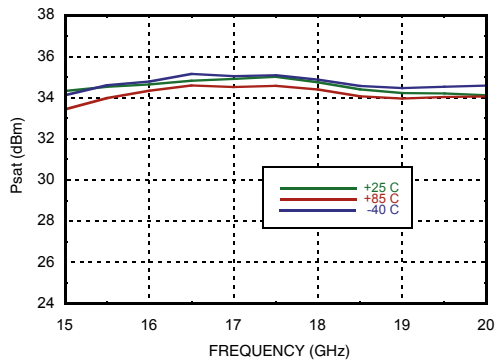

Psat vs. Supply Voltage

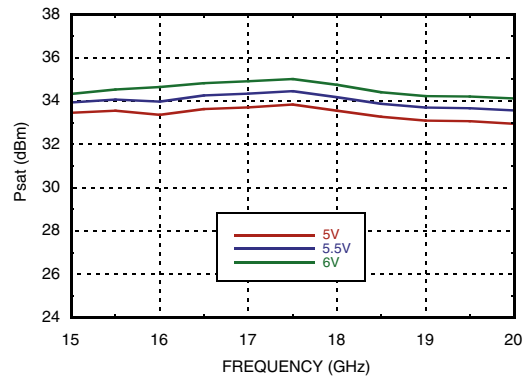

P1dB vs. Supply Current

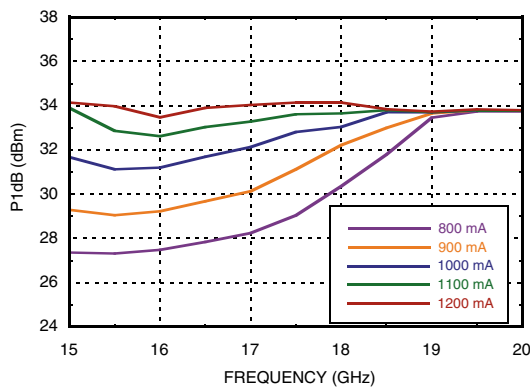

Psat vs. Supply Current

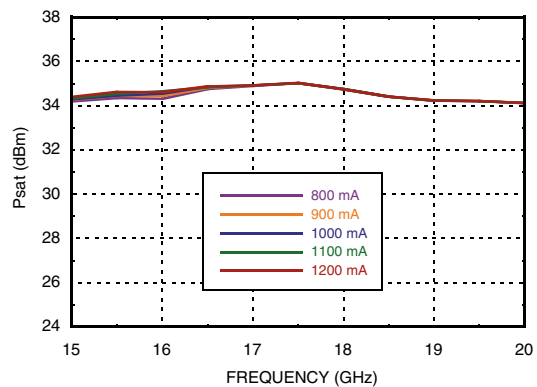

Information furnished by Analog Devices is believed to be accurate and reliable. However, no responsibility is assumed by Analog Devices for its use, nor for any infringements of patents or other rights of third parties that may result from its use. Specifications subject to change without notice. No license is granted by implication or otherwise under any patent or patent rights of Analog Devices. Trademarks and registered trademarks are the property of their respective owners.

For price, delivery, and to place orders: Analog Devices, Inc., One Technology Way, P.O. Box 9106, Norwood, MA 02062-9106 Phone: 781-329-4700 • Order online at www.analog.com Application Support: Phone: 1-800-ANALOG-D



GaAs pHEMT MMIC 2 WATT POWER AMPLIFIER, 15 - 20 GHz

Output IP3 vs. Temperature, Pout/tone = +20 dBm

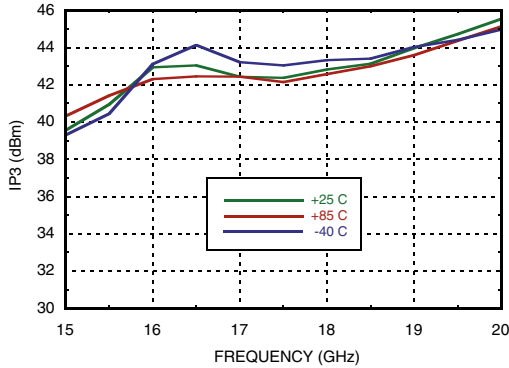

Output IP3 vs. Supply Current, Pout/tone = +20 dBm

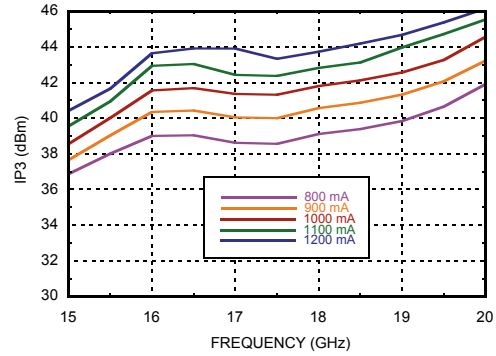

Output IP3 vs. Supply Voltage, Pout/tone = +20 dBm

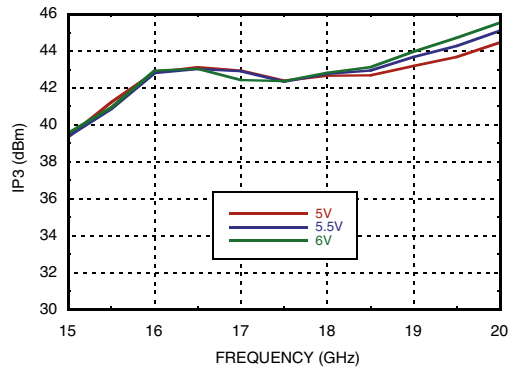

Output IM3 @ Vdd = +5V

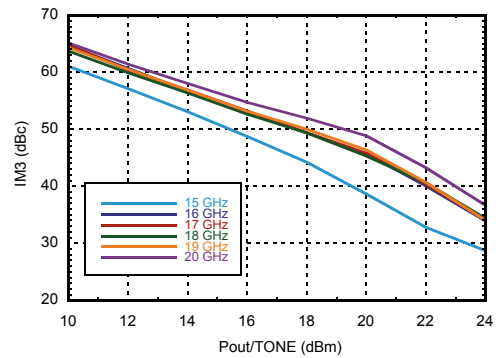

Output IM3 @ Vdd = +5.5V

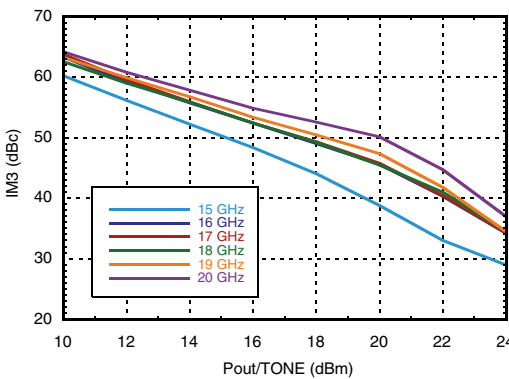

Output IM3 @ Vdd = +6V

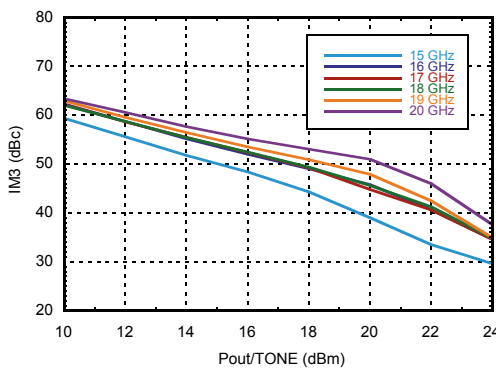

Information furnished by Analog Devices is believed to be accurate and reliable. However, no responsibility is assumed by Analog Devices for its use, nor for any infringements of patents or other rights of third parties that may result from its use. Specifications subject to change without notice. No license is granted by implication or otherwise under any patent or patent rights of Analog Devices. Trademarks and registered trademarks are the property of their respective owners.

For price, delivery, and to place orders: Analog Devices, Inc., One Technology Way, P.O. Box 9106, Norwood, MA 02062-9106 Phone: 781-329-4700 • Order online at www.analog.com Application Support: Phone: 1-800-ANALOG-D



GaAs pHEMT MMIC 2 WATT POWER AMPLIFIER, 15 - 20 GHz

Power Compression @ 17.5 GHz

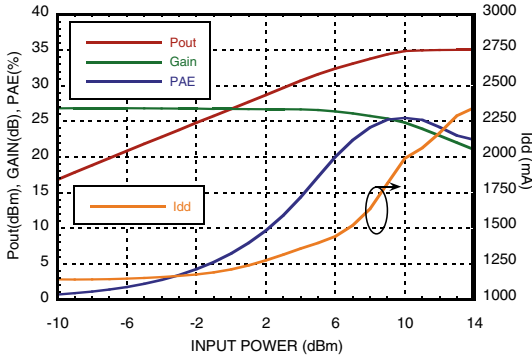

Reverse Isolation vs. Temperature

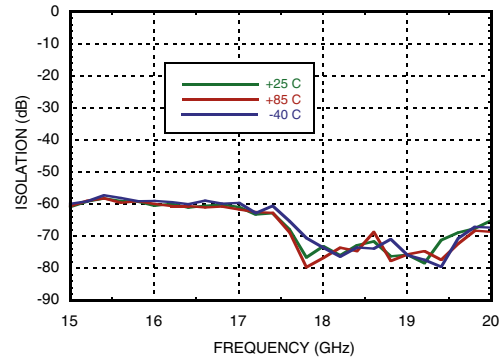

Gain & Power vs. Supply Current @ 17.5 GHz

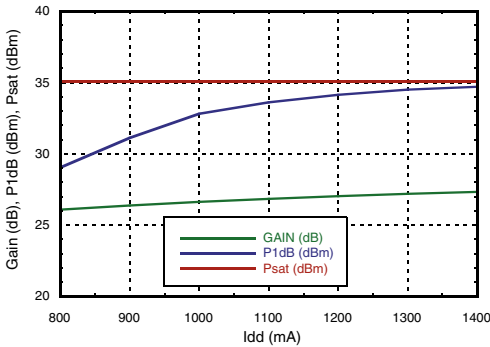

Gain & Power vs. Supply Voltage @ 17.5 GHz

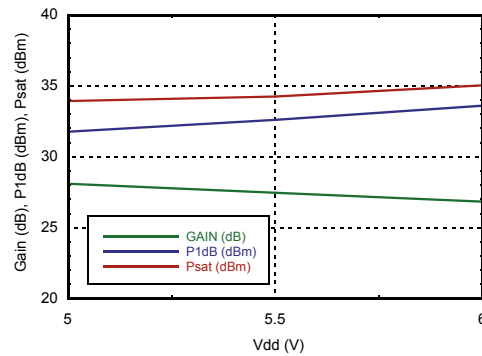

Power Dissipation

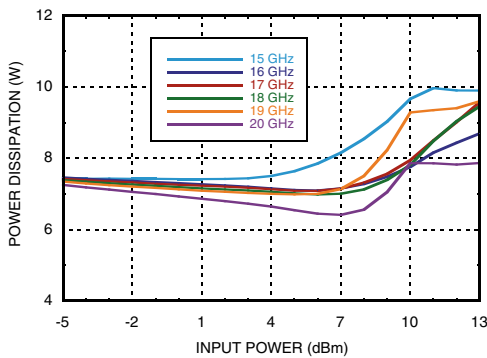

Detector Voltage vs. Temperature @ 17.5 GHz

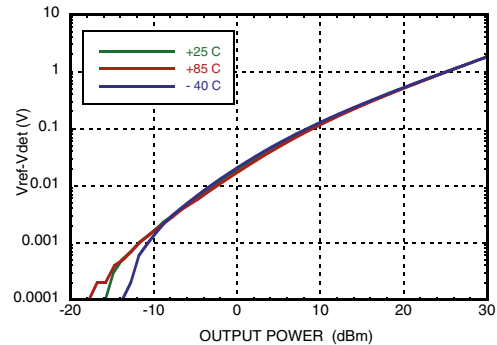

Information furnished by Analog Devices is believed to be accurate and reliable. However, no responsibility is assumed by Analog Devices for its use, nor for any infringements of patents or other rights of third parties that may result from its use. Specifications subject to change without notice. No license is granted by implication or otherwise under any patent or patent rights of Analog Devices. Trademarks and registered trademarks are the property of their respective owners.

For price, delivery, and to place orders: Analog Devices, Inc., One Technology Way, P.O. Box 9106, Norwood, MA 02062-9106 Phone: 781-329-4700 • Order online at www.analog.com Application Support: Phone: 1-800-ANALOG-D



GaAs pHEMT MMIC 2 WATT POWER AMPLIFIER, 15 - 20 GHz

Low DC Power Mode, Vdd = 5.5V, Idd = 1000 mA

P1dB vs. Temperature

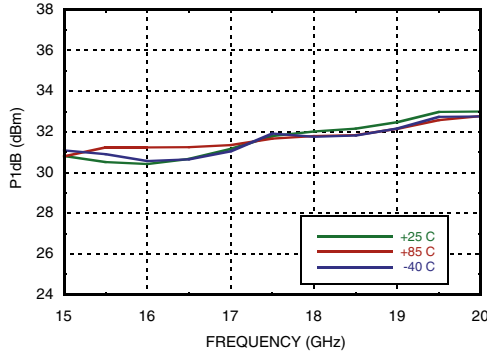

Psat vs. Temperature

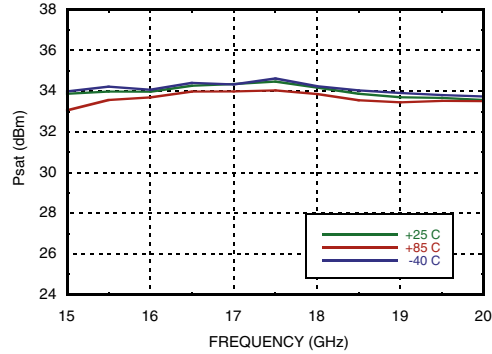

Output IP3 vs. Temperature, Pout/tone = +20 dBm

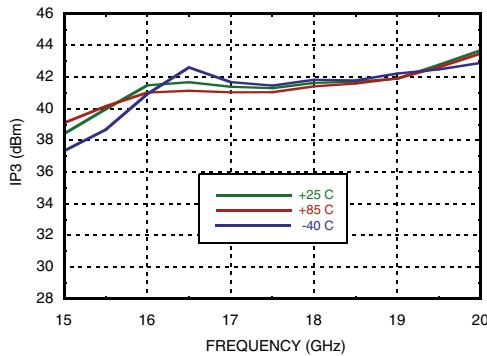

Output IM3 @ Vdd = +5.5V, 1000 mA

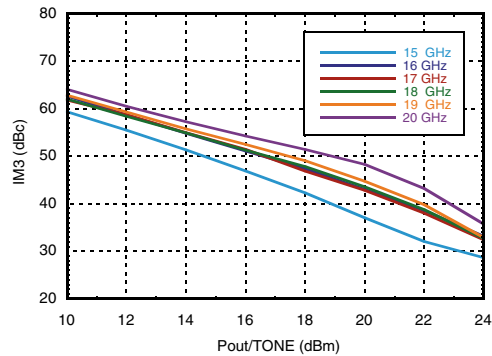

Power Compression @ 17.5 GHz

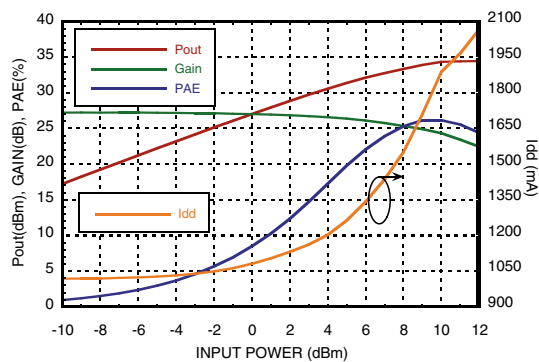

Power Dissipation

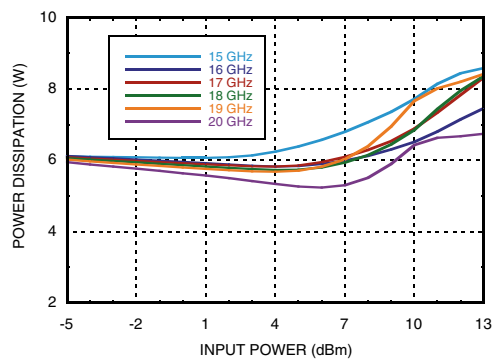

Information furnished by Analog Devices is believed to be accurate and reliable. However, no responsibility is assumed by Analog Devices for its use, nor for any infringements of patents or other rights of third parties that may result from its use. Specifications subject to change without notice. No license is granted by implication or otherwise under any patent or patent rights of Analog Devices. Trademarks and registered trademarks are the property of their respective owners.

For price, delivery, and to place orders: Analog Devices, Inc., One Technology Way, P.O. Box 9106, Norwood, MA 02062-9106 Phone: 781-329-4700 • Order online at www.analog.com Application Support: Phone: 1-800-ANALOG-D



GaAs pHEMT MMIC 2 WATT POWER AMPLIFIER, 15 - 20 GHz

Absolute Maximum Ratings

Drain Bias Voltage (Vdd)	+6.5 Vdc
Gate Bias Voltage (Vgg)	-3 to 0 Vdc
RF Input Power (RFIN)	+18 dBm
Channel Temperature	175 °C
Continuous Pdiss (T = 85 °C) (derate 129 mW/°C above 85 °C)	11.7 W
Thermal Resistance (channel to ground paddle)	7.7 °C/W
Storage Temperature	-65 to 150 °C
Operating Temperature	-40 to 85 °C
ESD Sensitivity (HBM)	Class 0, Passed 150V

Typical Supply Current vs. Vdd

Vdd (V)	Idd (mA)
+5	1100
+5.5	1100
+6	1100

Adjust Vgg to achieve Idd = 1100 mA



**ELECTROSTATIC SENSITIVE DEVICE
OBSERVE HANDLING PRECAUTIONS**

Outline Drawing

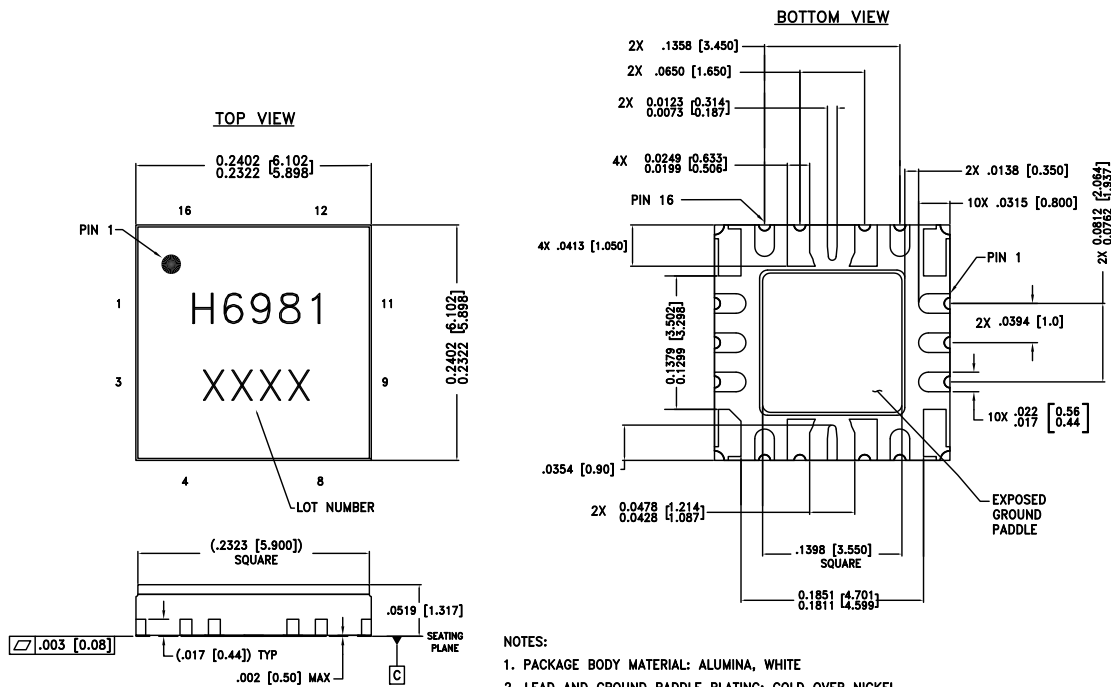

NOTES:

1. PACKAGE BODY MATERIAL: ALUMINA, WHITE
2. LEAD AND GROUND PADDLE PLATING: GOLD OVER NICKEL.
3. CHARACTERS TO BE BLACK INK MARKED WITH .018"MIN to .030"MAX HEIGHT REQUIREMENTS. UTILIZE MAXIMUM CHARACTER HEIGHT BASED ON LID DIMENSIONS AND BEST FIT. LOCATE APPROX. AS SHOWN.
4. ALL GROUND LEADS AND GROUND PADDLE MUST BE SOLDERED TO PCB RF GROUND.
5. REFER TO HITTITE APPLICATION NOTE FOR SUGGESTED PCB LAND PATTERN.

Package Information

Part Number	Package Body Material	Lead Finish	MSL Rating [2]	Package Marking [1]
HMC6981LS6	ALUMINA WHITE	Gold over Nickel	N/A	H6981 XXXX

[1] 4-Digit lot number XXXX

[2] Max peak reflow temperature of 260 °C



GaAs pHEMT MMIC 2 WATT POWER AMPLIFIER, 15 - 20 GHz

Pin Descriptions

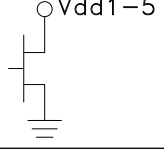
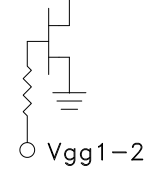
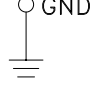
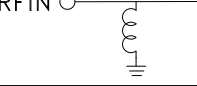
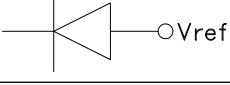
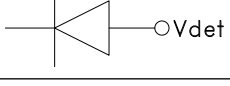
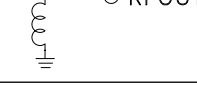
Pad Number	Function	Description	Interface Schematic
1, 2, 3, 10, 16	Vdd3, Vdd2, Vdd1, Vdd5, Vdd4	Drain bias voltage. External bypass capacitors of 100 pF, 10 nF, and 4.7 uF are required for each pin.	
4, 9	Vgg1, Vgg2	Gate control for PA. Adjust Vgg to achieve recommended bias current. External bypass capacitors 100 pF, 10 nF, and 4.7 uF are required. Apply Vgg bias to either pin 4 or pin 9.	
5, 7, 13, 15	GND	These pins and exposed ground paddle must be connected to RF/DC ground.	
6	RFIN	This pin is DC coupled and matched to 50 Ohms.	
11	Vref	DC voltage of diode biased through external resistor used for temperature compensation of Vdet. See Application Circuit.	
12	Vdet	DC voltage representing RF output power rectified by diode which is biased through an external resistor. See Application Circuit.	
14	RFOUT	This pin is DC coupled and matched to 50 Ohms.	



**GaAs pHEMT MMIC 2 WATT
POWER AMPLIFIER, 15 - 20 GHz**

Application Circuit

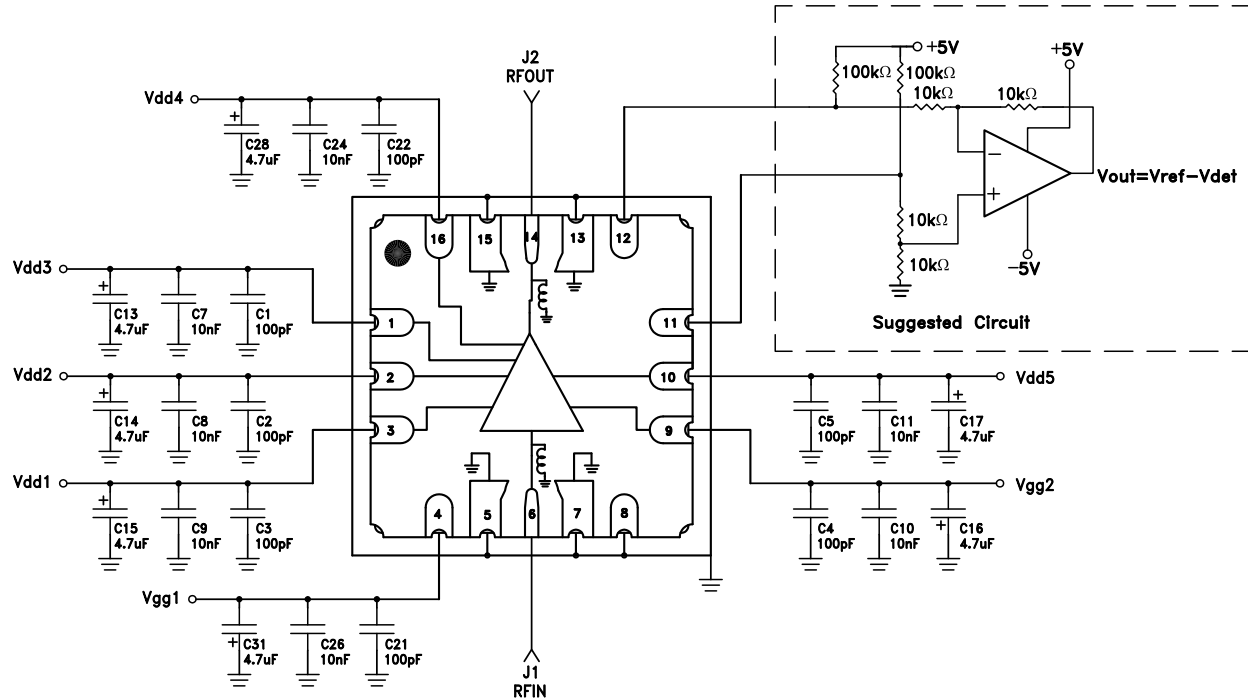

Information furnished by Analog Devices is believed to be accurate and reliable. However, no responsibility is assumed by Analog Devices for its use, nor for any infringements of patents or other rights of third parties that may result from its use. Specifications subject to change without notice. No license is granted by implication or otherwise under any patent or patent rights of Analog Devices. Trademarks and registered trademarks are the property of their respective owners.

For price, delivery, and to place orders: Analog Devices, Inc., One Technology Way, P.O. Box 9106, Norwood, MA 02062-9106 Phone: 781-329-4700 • Order online at www.analog.com Application Support: Phone: 1-800-ANALOG-D

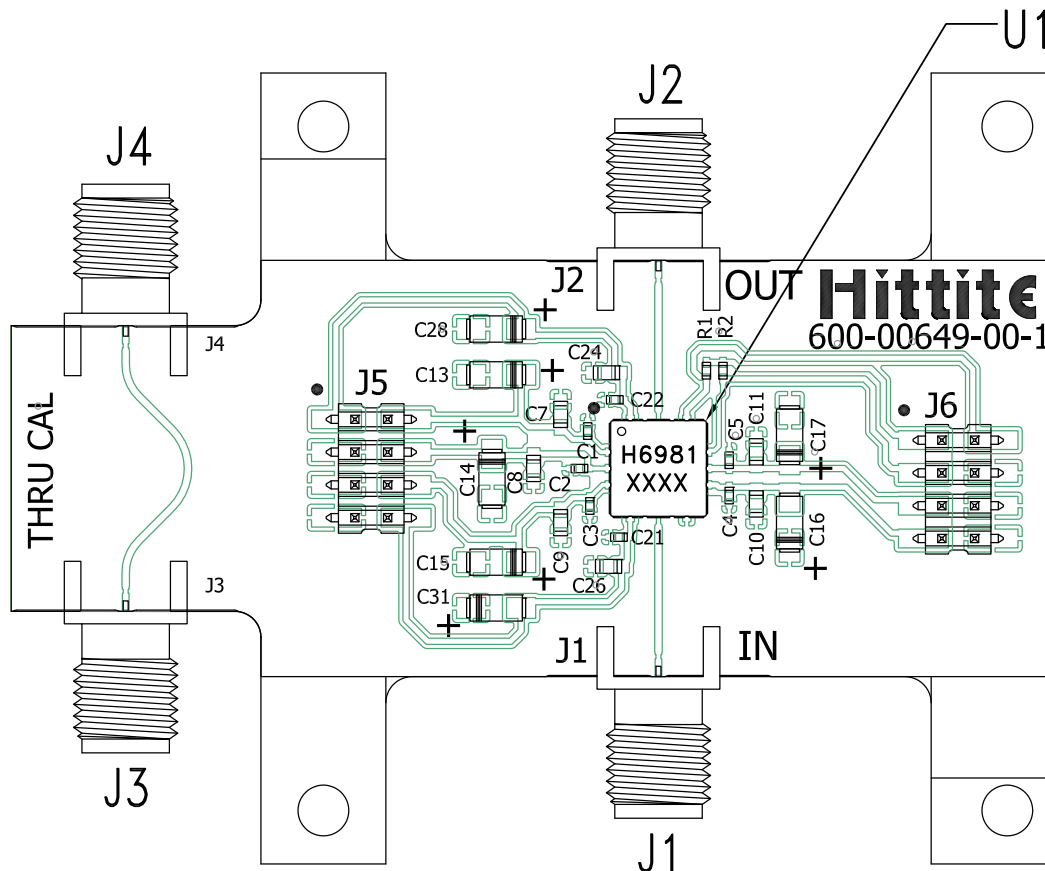
**GaAs pHEMT MMIC 2 WATT
POWER AMPLIFIER, 15 - 20 GHz**
Evaluation PCB

List of Materials for Evaluation PCB EVAL01-HMC6981LS6 ^[1]

Item	Description
J1 - J4	"K" Connector, SRI
J5, J6	DC Pin
C1 - C5, C21, C22	100 pF Capacitor, 0402 Pkg.
C7 - C11, C24, C26	10000 pF Capacitor, 0603 Pkg.
C13 - C17, C28, C31	4.7 uF Capacitor, Case A Pkg.
R1, R2	42.6K Ohm Resistor, 0402 Pkg.
U1	HMC6981LS6 Amplifier
PCB ^[2]	600-00649-00 Eval Board

[1] Reference this number when ordering complete evaluation PCB

[2] Circuit Board Material: Rogers 4350

The circuit board used in the application should use RF circuit design techniques. Signal lines should have 50 Ohm impedance while the package ground leads and exposed paddle should be connected directly to the ground plane similar to that shown. A sufficient number of via holes should be used to connect the top and bottom ground planes. The evaluation circuit board shown is available from Hittite upon request.